

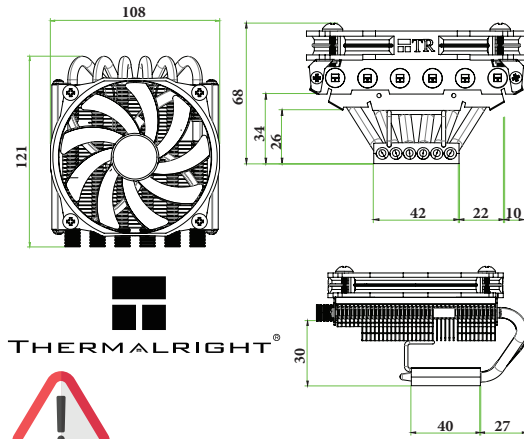

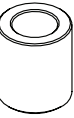

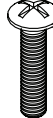

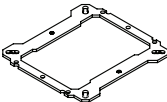

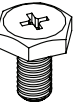

AXP-100 C65 Installation Manual

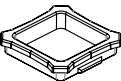
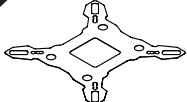
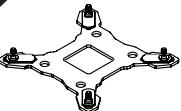
Part List

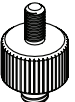
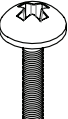

Please follow the Installation Guide before installing this product.
 Please do NOT modify or disassemble this product.
 Please keep this product AWAY from children.
 Please do NOT use this product for the non-PC environment.
 Please do NOT apply too much thermal paste will lower heat conductivity and cooling performance!
 To prevent electrical shocks, please turn off system power and unplug the power of the system before beginning the installation.

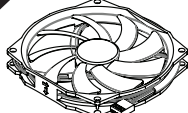
A  Nylon Tube x5	B  6#32 L17 Screw x5	C  Anchoring Mount x1	D  TF4 x1	E  M3L6 Screw x3	F  Mounting Plate x1
G  775 Back Plate Cap x1	H  Mylar x1	I  Metal Back Plate x1	J  LGA 115x Screw Pillars x4	K  Screw Nut x4	L  LGA2011 Double Head Screw x4
M  M3L17 Screw x5	N  M3L28 Screw x5	O  M3L4 Screw x5	P  Enhanced Fan Mount x1	Q  AXP-100 C65 x1	R  TY-100BP x1

AMD AM4 Platform

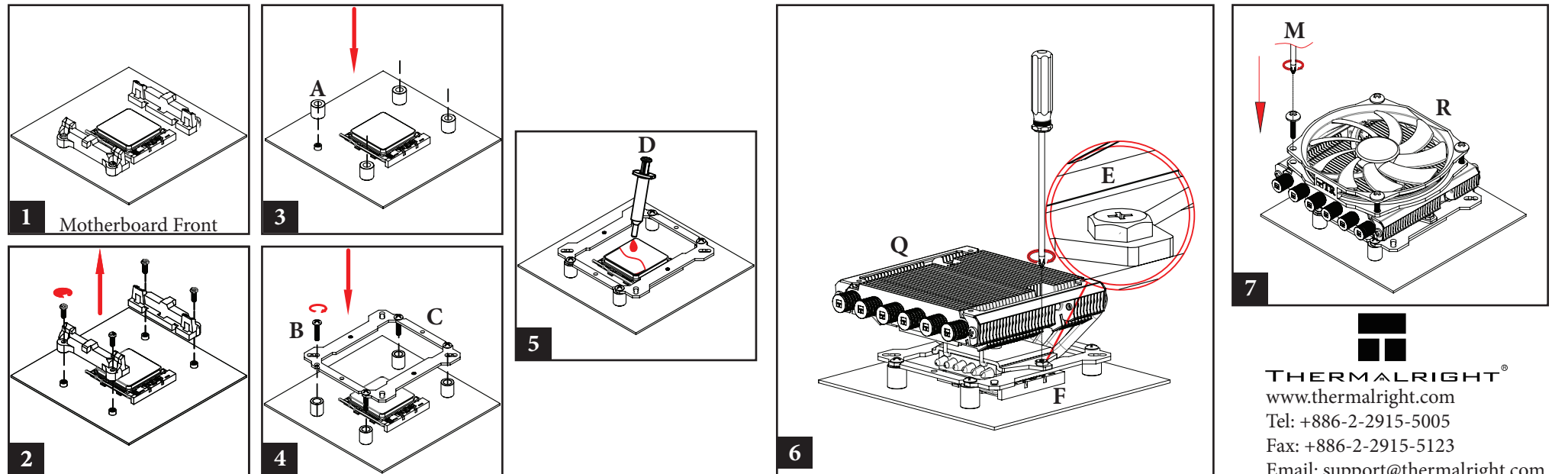

THERMALRIGHT
 www.thermalright.com
 Tel: +886-2-2915-5005
 Fax: +886-2-2915-5123
 Email: support@thermalright.com

Intel LGA 115x Platform

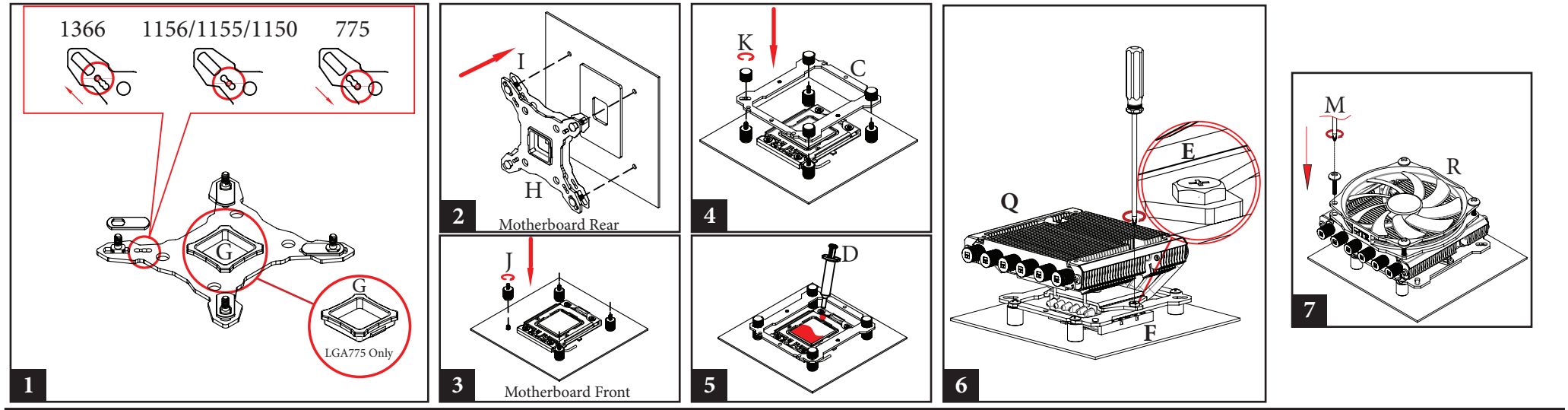

Intel LGA 2011 Platform

